

Laufschiene

massiv Edelstahl geschliffen Korn 240
 D: 25 mm
 bitte Bestellvorlage auf Seite 25 verwenden

Art.Nr.	Länge L
200-0300	1500
200-0301	2000
200-0302	2500
200-0324	3000

Gerne fertigen wir Sonderabmessungen.

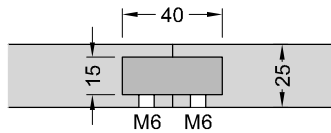

Verbindungseinheit

Edelstahl geschliffen Korn 240

Art.-Nr. 200-0303

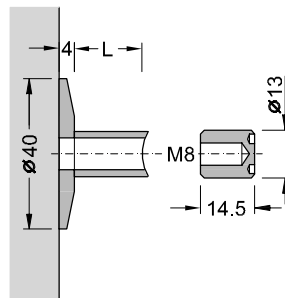

Wandbefestigung

mit Stockschraube M8 x 70

Art.Nr.	Länge L	
200-0304	5	für Glastüre
200-0305	19	für Holztüre

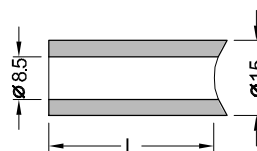

Distanzstück für Türen

mit Türrahmen
 zum Ausgleich

Art.Nr.	Länge L	
200-0306	19	für Glastüre
200-0307	33	für Holztüre

Zubehör für Schiebetürbeschläge

01

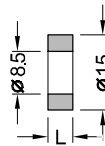
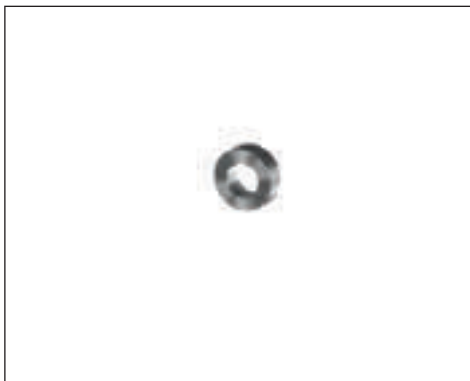

Distanzscheibe

zum Ausgleich

Art.Nr.	Länge L
200-0308	2
200-0309	5
200-0310	10

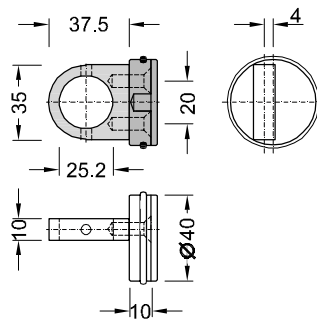

Türstopper

Edelstahl geschliffen Korn 240

Art.-Nr. 200-0311

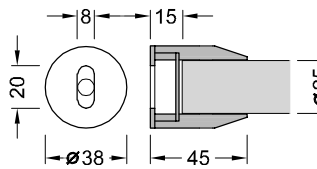

Wandbefestigung stirnseitig

Edelstahl geschliffen Korn 240

Art.-Nr. 200-0312

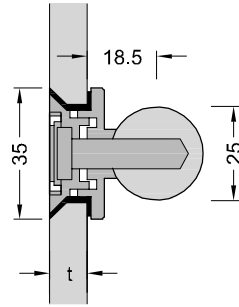

Senkzierschraube

zur Befestigung Glas - Laufschiene
Glasbohrung siehe unten

Art.-Nr. 200-0313

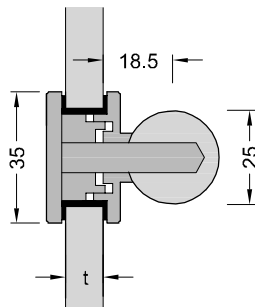

Blendschraube

zur Befestigung Glas - Laufschiene
Glasbohrung siehe unten

Art.-Nr. 200-0314



Deckenprofil

Aluminium
U-Profil 40/20/40, t = 2 mm

Art.Nr.	
200-0315	natur eloxiert
200-0316	Edelstahloptik



Bodenprofil

Aluminium
U-Profil 20/20/20, t = 2 mm

Art.Nr.	
200-0317	natur eloxiert
200-0318	Edelstahloptik

Glasbohrung für Senkzierschraube mit der Art.Nr. 200-0313

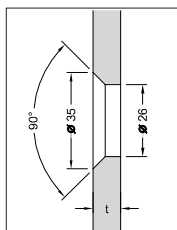

Glasbohrung für Blendschraube mit der Art.Nr. 200-0314

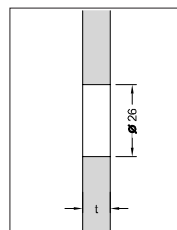

Zubehör für Schiebetürbeschläge

01

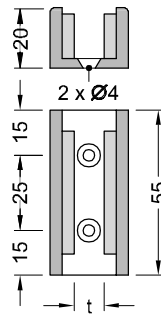

Bodenführung für Glastür

Edelstahl geschliffen Korn 240
mit Spezialfilz

Art.Nr.	Glasstärke
200-0319	8 - 12

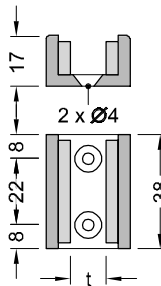

Bodenführung für Glastür

Edelstahl geschliffen Korn 240
mit Spezialfilz

Art.Nr.	Glasstärke
200-0320	8
200-0321	10
200-0322	12

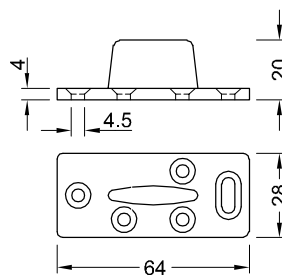

Bodenführung für Holztür

Art.-Nr. 200-0323

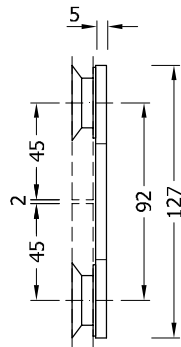

Glas-Glas Verbinder

Edelstahl geschliffen Korn 240
mit Senkzierschraube D:35 mm

Art.Nr.	Glasstärke
200-0330	6 - 8
200-0331	10 - 12

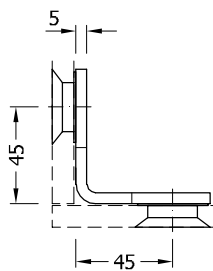

Glas-Glas Verbinder

Edelstahl geschliffen Korn 240
Winkel 90°
mit Senkzierschraube D:35 mm

Art.Nr.	Glasstärke
200-0332	6 - 8
200-0333	10 - 12

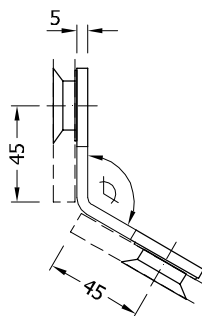

Glas-Glas Verbinder

Edelstahl geschliffen Korn 240
Winkel von 91° - 179
bitte bei Bestellung angeben
mit Senkzierschraube D:35 mm

Art.Nr.	Glasstärke
200-0334	6 - 8
200-0335	10 - 12

andere Winkel auf Anfrage

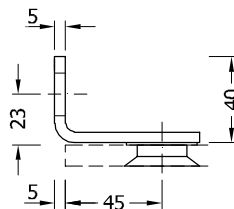

Glas-Wand Verbinder

Edelstahl geschliffen Korn 240
mit Senkzierschraube D:35 mm

Art.Nr.	Glasstärke
200-0336	6 - 8
200-0337	10 - 12

Glasbohrung

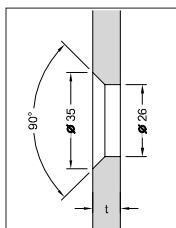

Zubehör für Schiebetürbeschläge

01

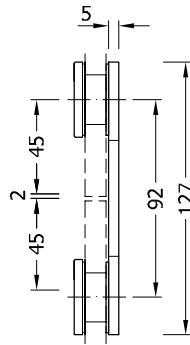

Glas-Glas Verbinder

Edelstahl geschliffen Korn 240
mit Blendschraube

Art.Nr.	Glasstärke
200-0338	6 - 8
200-0339	10 - 12

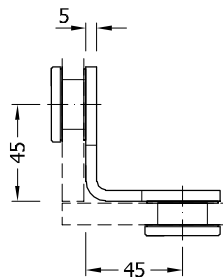

Glas-Glas Verbinder

Edelstahl geschliffen Korn 240
Winkel 90°
mit Blendschraube

Art.Nr.	Glasstärke
200-0340	6 - 8
200-0341	10 - 12

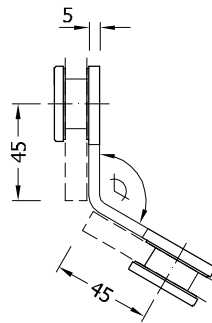

Glas-Glas Verbinder

Edelstahl geschliffen Korn 240
Winkel von 91° - 179
bitte bei Bestellung angeben
mit Blendschraube

Art.Nr.	Glasstärke
200-0342	6 - 8
200-0343	10 - 12

andere Winkel auf Anfrage

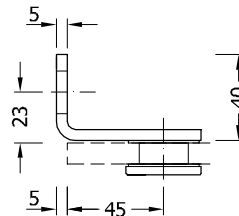

Glas-Wand Verbinder

Edelstahl geschliffen Korn 240
mit Blendschraube

Art.Nr.	Glasstärke
200-0344	6 - 8
200-0345	10 - 12

Glasbohrung

